

Product Type: IP67 connector

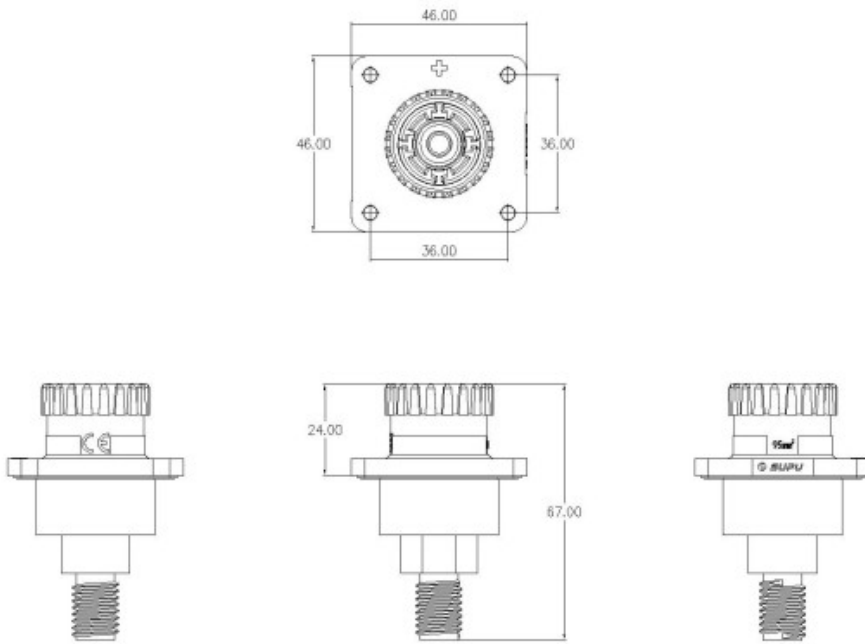

Product Name:ESF-RS300A95YP4

Product Description: Connectors suitable for energy storage modules Color: Orange Rated voltage: 1500V DC Rated current: 300A Connection method: Nuts Contact type: Pin wire cross-section: 95mm² cable outer diameter: 15.2mm to 17.7mm

Product Size



Parameters

<p> SUPU ID</p>	ESF-RS300A95YP4
<p> Number of connections</p>	1
<p> Connection method</p>	Bolt connection

☞ Protection Level	IP 67
☞ Operating temperature range	-40°C~+125°C
☞ Insulation material	III
☞ Insulation material group	III
☞ Contact material	Copper alloy
☞ Contact plating	Ag,Plated
☞ Insertion/withdrawal cycles	100
☞ Insertion force	≤75N
☞ Withdrawal force	≥10N

Technical data

☞ IEC Rated Current	300A
☞ IEC Rated Voltage	1500V DC
☞ Overvoltage category	III
☞ Degree of pollution	3
☞ Rated impulse voltage	12.3KV
☞ Stripping length	20±1mm
☞ Rated cross section(AWG)	3/0 AWG
☞ External cable diameter	15.2mm~17.7mm

Commercial data

☞ Order No	ESF-RS300A95YP4
☞ Packing unit	Pcs
☞ Minimum order quantity	1

Ningbo SUPU Electronics Co., Ltd.

Address: No. 150, Xinxing 4th Road, High-tech Industrial Development Zone,

Cixi City, Zhejiang Province, China

Zip code: 315303

Switchboard: +86 574-63288158

Fax: +86 574-63288170

E-mail:supucontact@supu.cn

Service Hotline: 400-626-6336



Wechat